

LINEAR BEARINGS TURCITE[®] SLYDWAY[®]

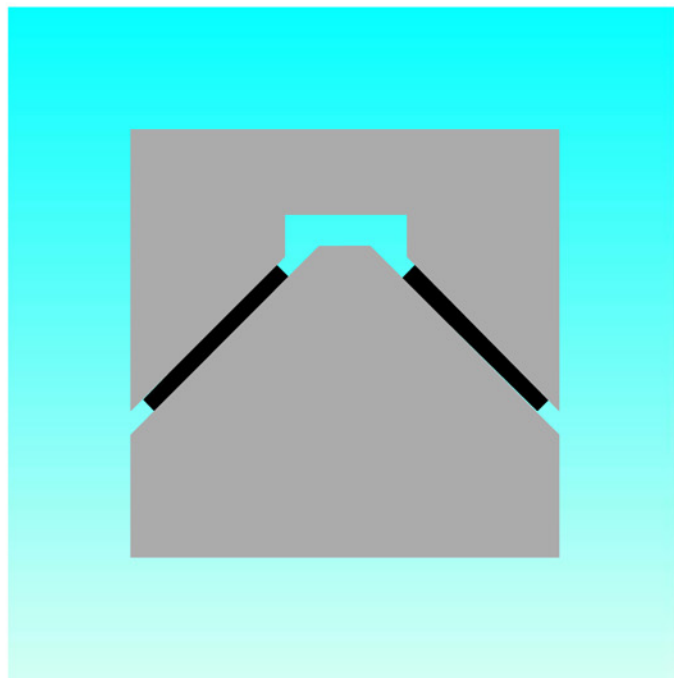

- **Stick-slip free Linear Bearings -**
- **High Performance Linear Bearings for Guideways -**

- **Material -**

- **Turcite[®] -**





Contents

General	2
Design Instructions	5
Installation Instructions	8
Quality Criteria	11
Storage and Shelf Life	11



The information in this brochure is based on many decades of experience in the manufacture and application of sealing and bearing systems. However, unknown parameters and conditions may restrict general statements during usage. It is vital that Customers satisfy themselves as to the suitability of individual products through adequate testing. For this reason, and due to the wide range of applications of our products, Busak+Shamban can accept no liability as to the suitability or correctness of our recommendations in individual cases.

The application limits for pressure, temperature, speed and media given in this catalogue are maximum values determined in the laboratory. During practical applications it should be remembered that due to the interaction of the operating parameters, the maximum values must be set correspondingly lower. For exceptional operating conditions, please contact your Busak+Shamban representative.

This edition supersedes all previous catalogues. This catalogue, or any part thereof, may not be reproduced without our permission.

®All trademarks are the property of Busak+Shamban, Dowty Engineered Seals, Forsheda. QUAD-RING® is a trademark of Quadion Corporation.

©Busak+Shamban. All rights reserved.

The turquoise colour is a registered trademark of Busak+Shamban.



■ General

Turcite[®] Slydway[®] is a high performance thermoplastic material for use on linear bearing application as found on the guideways of machine tools and other linear bearing applications.

Guideways on machine tools ensure the exact direction of motion of components such as slides, sleeves, quills, plungers, etc. At the same time, guideways must bear the weight of the guided components and workpieces and absorb the machining forces without deformation.

This places critical demands on the machine tool guideways:

- high positional accuracy and repeatability of the working movements
- high performance over many years

- low production costs
- low friction without stick-slip as a precondition for positional accuracy at differing velocities
- low wear, even in the event of poor or failed lubrication
- backlash-free or minimum backlash for high repeatability even under load
- good damping behaviour even with interrupted cutting operations to minimize chatter.

Turcite[®] Slydway[®] has been well proven worldwide for many years in many sectors of machine tool and other heavy duty engineering industries (see Figure 1).

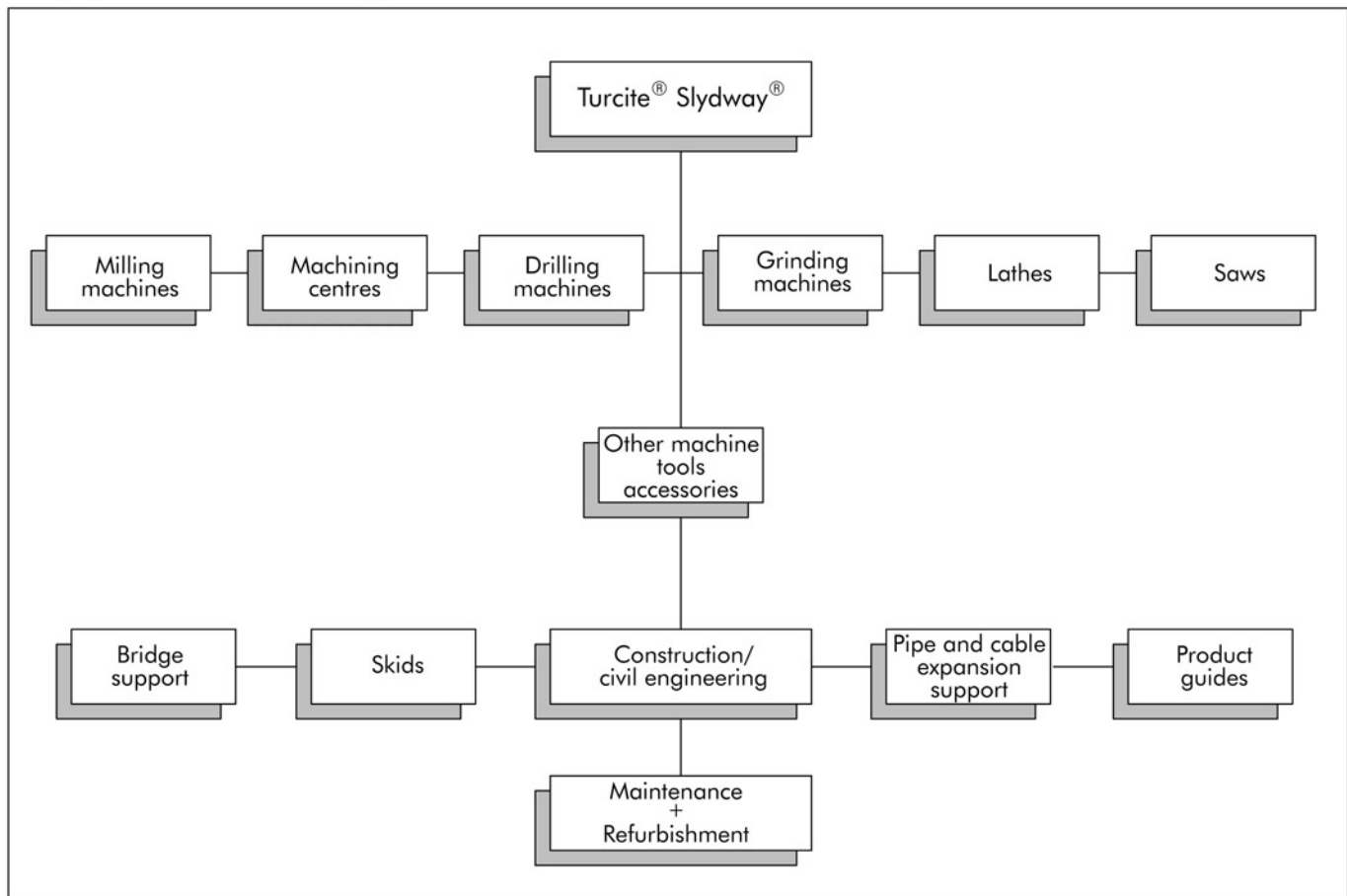

Figure 1 Fields of Application for Turcite[®] Slydway[®]



Application

Slydway® can be used in a wide variety of applications. The application examples show forms of sliding slydways coated with Turcite® already in use in the machine tool industry (figure 2 on page 4).

Slydway® is also applicable to other heavy duty linear bearings in the construction or civil engineering markets including bridge supports, skids, pipe or cable expansion supports, telescopic arms or any other linear application. Slydway® is normally bonded to the moving surface only of a linear bearing application. It is subsequently finish machined by milling, grinding and/or scraping to provide a suitable counterface to the cast iron, steel or other static face.

Designs

Slydway® meets the modern demands made by different guide systems and dimensions. It is available in thicknesses of 0.5 to 5 mm and widths up to 300 mm. It can be supplied cut to the specified length or as off-the-roll material. Table III, page 10, shows the standard sizes available.

Slydway® is especially applicable to the refurbishment of worn machine tools. Worn linear bearings can be machined back and brought to the original working tool heights and centre lines by the application of Slydway® material of suitable thickness.

Characteristics

Slydway® is manufactured from the specially developed high-performance thermoplastic Turcite® and modified for the special requirements for linear bearing applications. In order to achieve good adhesion when bonding with the machine components, the surface is chemically treated.

Advantages

- low friction, no jamming, no stick-slip, particularly at low sliding speeds
- good mechanical properties, wear-resistant and dimensionally stable
- safety against dry running in the event of poor or no lubrication
- high wear resistance, thus ensuring a long service life
- good emergency running properties, no tendency to seize
- damps and absorbs vibrations
- impervious to soiling and moisture
- chemically resistant to aggressive cooling lubricants
- dimensions available from stock, simple and cost-effective handling.

Material characteristics - Turcite® TB

Only one side is chemically treated for applying adhesive:

Colour of the treated surface: brown to dark brown

Colour on the non-treated surface (sliding surface): green-grey

Water absorption: < 0.01 %

Linear coefficient of expansion: $6 \times 10^{-5} 1/K$

Thermal conductivity at 20 °C: 0.8 W/m • K

Max. pressure load for 1% deformation: 930 N/cm²

Hardness: 60 Shore D

Modulus of elasticity at 40°C: 1.000 N/mm²

Chemical resistance: Turcite® TB has a very good chemical resistance and is resistant to coolants, clear coolants and lubricants.

Material characteristics - Turcite® T51

Both sides are chemically treated and can both be used for applying adhesive:

Colour of the treated surfaces: black

Colour after machining the treated surface (sliding surface): black

Water absorption: < 0.01 %

Linear coefficient of expansion: $1 \times 10^{-4} 1/K$

Thermal conductivity at 20°C: -

Max. pressure load for 1% deformation: -

Hardness: 66 Shore D

Modulus of elasticity at 40°C: 1.000 N/mm²

Chemical and mechanical resistance: Turcite® T51 has good resistance against lubricated and poor lubricated moving components. Good sliding properties against soft metal surfaces - see "Mating surfaces" on page 7.

Storage instructions

Slydway® should be stored at room temperature and in dry environments protected from light. The shelf life is limited and depends on the storing conditions.



Designs

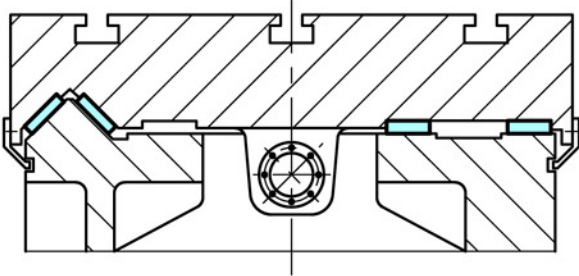

Flat tapered Guideway

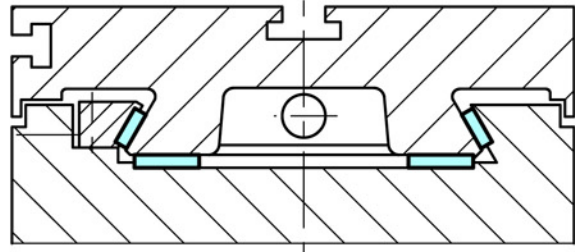

Dovetail Guideway

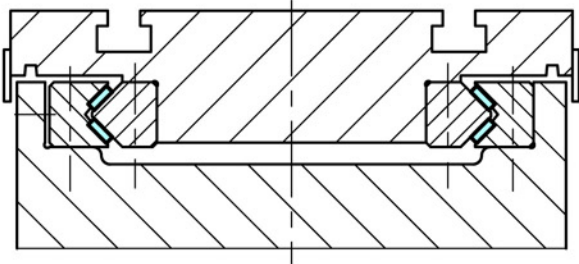

V-Guideway

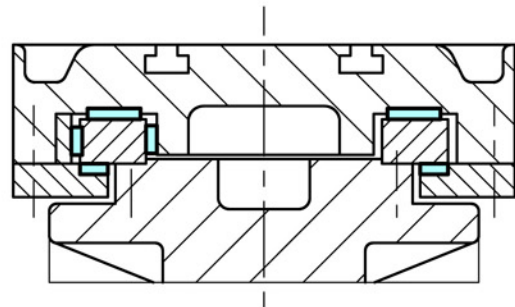

Flat Guideway

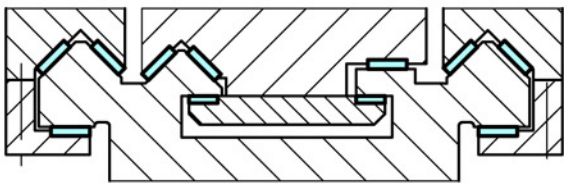

Double V-Guideway

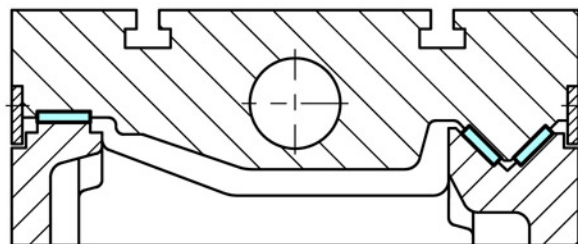

Flat V-Guideway

Figure 2 Slydway® installation examples



Design Instructions

Load and contact deformation

In conjunction with the contact deformation, the load is of great significance for the operating precision of the linear bearing. The surface pressures for Turcite® Slydway® in machine tool construction are generally selected between 20 and 200 N/cm².

The load-carrying capacity is dependent on the thickness of the Turcite® bearing material and the surface roughness.

Figure 3 shows the contact deformation as a function of different material thicknesses "w" for Turcite® TB with a surface roughness of R_a = 0.6 μm. As can be seen from the diagram, Turcite® TB can be subjected to even more than the optimum range.

Within the working range depicted, the coefficient of friction of the Turcite® TB material remains practically unchanged.

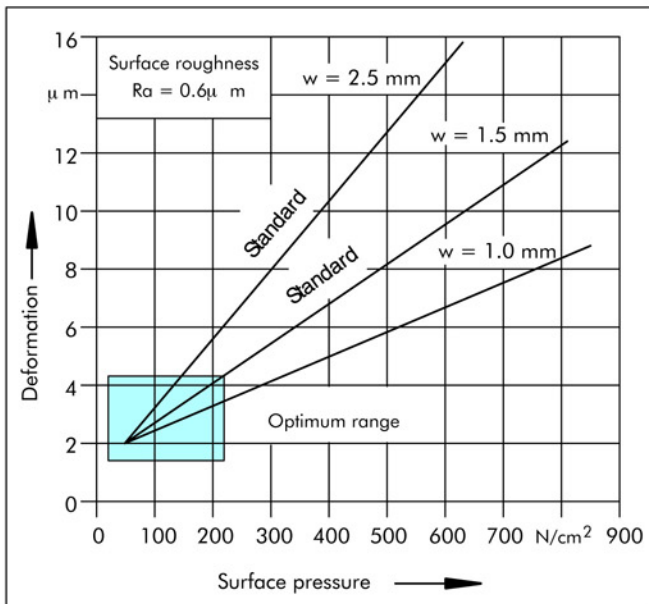

Figure 3 Deformation as a function of surface pressure and thickness "w" of the Turcite® TB material

Surface roughness

Turcite® TB and Turcite® T51 sliding surfaces can be finish machined by milling, grinding and/or scraping. The surface quality should be R_a = 0.6 μm. Minor deviations such as shown in figure 4 have an insignificant effect on the friction behaviour. However, with greater surface roughness the contact deformation and wear would increase. An insufficient surface roughness influences the sliding behaviour as the sliding surfaces stick together (adhesion).

Figure 4 shows an optimum surface roughness range which should be achieved during final machining of the surface.

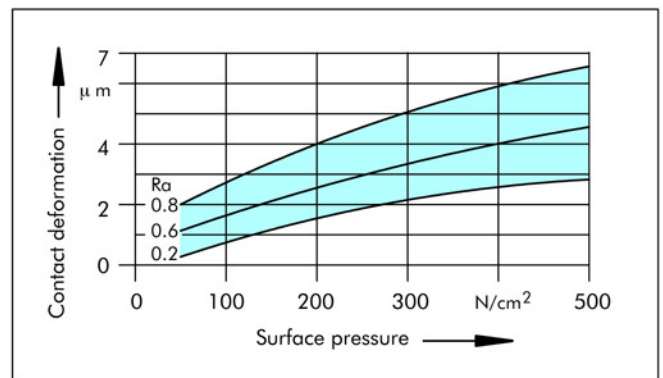

Figure 4 Deformation as a function of surface pressure for different surface roughness



Coefficients of friction

In use Slydway® displays only a slight difference between static friction and dynamic friction, thus eliminating any stick-slip. When used in numerically controlled machines, this produces higher positioning and reproduction precision.

Static friction

The coefficient of static friction for a Slydway® bearing depends on the material pairing in question and on the surface roughness of the Turcite®-B sliding surface, on the mating surface and on the lubrication.

Figure 5 shows the range of static friction when using different oils. The values were determined on a scraped Turcite® TB sliding surface with a surface contact pressure of 35 N/cm² and a surface roughness of the guide of R_a = 0.6 µm.

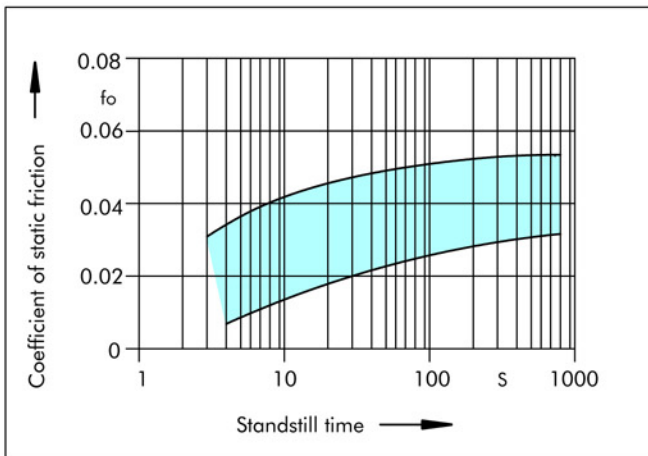

Figure 5 Range of the coefficient of static friction (fo) for Turcite® TB as a function of the standstill time when using different lubricants

Dynamic friction

The dynamic friction for a Slydway® has a practically linear pattern over the whole speed range. The good material pair of Turcite® TB and hardened steel guides can be clearly seen in the mixed friction zone. With a combination of a surface load of 35 N/cm² and a scraped Turcite® TB surface, the coefficient of friction reaches

f = 0.022 - 0.055.

Figure 6 shows the least differences at the transition to the hydrodynamic range. With higher surface pressures of up to 200 N/cm², the sliding behaviour changes only insignificantly.

Good lubrication is of paramount importance in order to achieve a controlled level of dynamic friction.

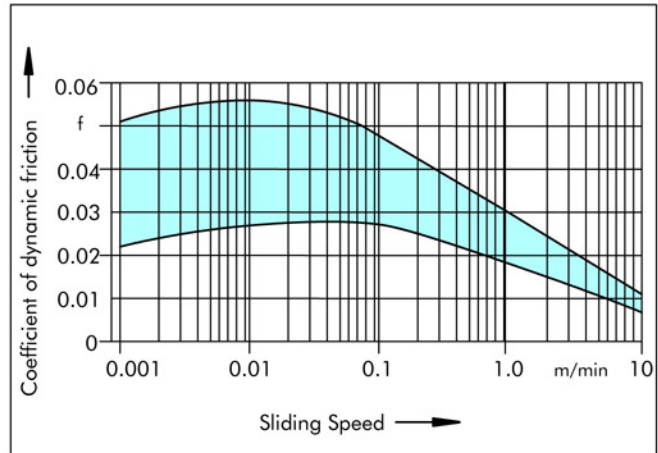

Figure 6 Range of the coefficient of dynamic friction (f) as a function of the sliding speed when using different lubricants

Wear

The service life and the continuous precision of Slydway® is determined primarily by its wear behaviour. Slydway® linear bearing are generally supplied with adequate lubrication.

Should the lubricant supply suddenly be interrupted, Slydway® will remain functional with low wear even for prolonged periods due to the self-lubricating properties of the material. Very low wear rates are achieved using the combination of Slydway® and hardened mating surface.

The wear behaviour is determined to a great extent by the ambient influences. It is important to protect the guides from external soiling by using covers and seals.

Slydway® has the great advantage of being able to absorb and embed small dirt particles, thus preventing immediate seizing, damage and extreme wear of the guides.



Start-up phase

A linear bearing application, using Slydway® should always be well lubricated during the start-up phase. During the start-up phase, very fine particles of the Turcite® material are deposited on the mating surface.

This leads to a slight shading of the metallic running surfaces. The start-up phase is then concluded with the smoothing phase. A very low level of friction and wear is then reached which remains essentially constant (Figure 7).

The guides can then be used for continuous operation.

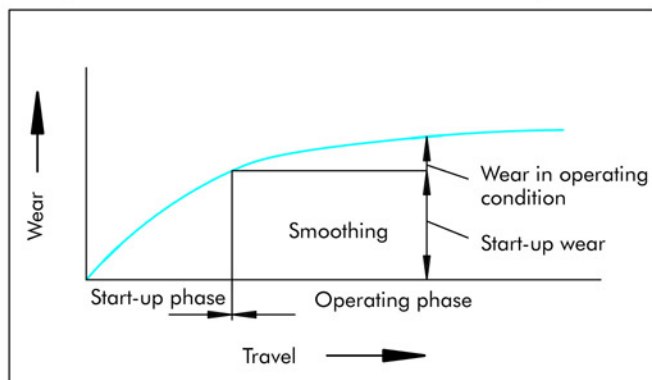

Figure 7 Wear as a function of the operating condition

Sliding wear

Slydway® are set backlash-free or even slightly preloaded, thus ensuring a very high continuous precision even over many years. The sliding behaviour is then determined primarily by the lubricant and the surface finish.

Figure 8 shows the wear behaviour of a scraped Turcite® TB Slydway® with a mean load of 50 N/cm² with adequate lubrication.

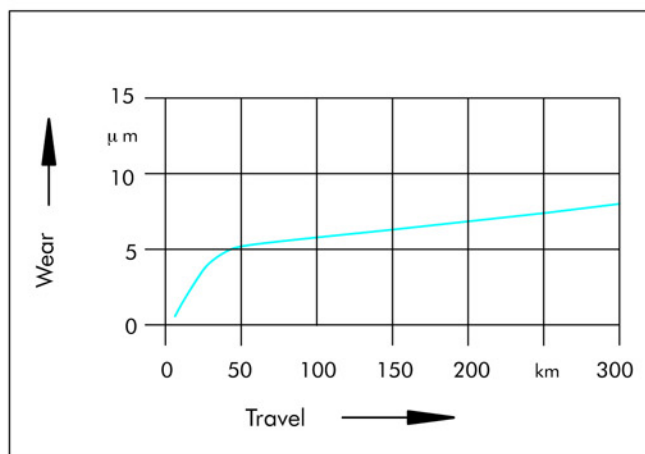

Figure 8 Wear behaviour of Turcite® TB Slydway®

Mating surfaces

In order to ensure a long service life, demands must also be made on the surface finish of the mating surface. The following values are recommended:

for steel	R_a	= 0.2 to 0.4 µm
	R_z	= 1.6 to 3.2 µm
	R_{max}	= 2.5 to 5.0 µm
for grey cast iron	R_a	= 0.2 to 0.8 µm
	R_z	= 1.6 to 6.3 µm
	R_{max}	= 2.5 to 10.0 µm

(These figures are only valid for Turcite® TB Slydway® and Turcite® T51 Slydway® applications).

Steel and cast iron are frequently used as materials for mating surfaces. Hardened mating surfaces are generally preferred for precision guides subject to high loads. In practice, hardnesses of approx. 60 HRc for steel and approx. 240 HB for cast iron have been found to be effective.

These sliding surfaces are not normally subject to any wear. For guide systems subject to less wear, unhardened and wear-resistant mating surfaces can also be used.

Mating surfaces of bronze, aluminium (untreated) or plastics - please contact your local Busak+Shamban Company for further information.

Temperature

The temperature at the sliding surfaces should be kept as constant as possible. In the event of elevated temperatures, an adequate heat dissipation must be assured by means of lubrication.



■ Installation instructions

Fixing Slydway® material

Slydway® material is fixed to the base material by bonding. Performed with the necessary care, bonding is a reliable and inexpensive fixing method.

Surface Preparation:

The preparation of the parts to be bonded together is of ultimate importance for achieving a good bond.

Machining of the adhesive surface is crucial for optimum bonding of Slydway®. To a certain extent, the surface roughness assists the bonding ability of the adhesive.

Surface roughness $R_a = 0.8$ to $3.2 \mu\text{m}$.

Additional possibilities of roughening the surface are sandblasting and rubbing with emery cloth (grain size: 100).

Cleaning the surface for bonding

Before applying the adhesive, the bonding surfaces must be cleaned thoroughly and freed from oil, grease, dust and rust. Impurities can be removed by washing with a commercially available degreasing agent such as acetone (oil-free), etc. When refurbishing machine tools with cast iron surfaces, flame treating of the porous surface to remove embedded oil deposits may be beneficial.

Bonding Slydway®

Slydway® should be bonded in a clean environment and at normal room temperature, ideally 20°C . A good two-component epoxy-resin adhesive is used. After mixing, apply the adhesive components to both parts to be bonded using a serrated spatula. Place Slydway® material onto the surfaces to be joined and load them uniformly to eliminate any air and excess adhesive.

Important Note:

Turcite TB is treated for bonding on one side only !

Apply adhesive to the dark brown side only



Try to avoid adhesive on this side



The parts should not shifted relative to one another during the prescribed hardening time. Finish machining of the Slydway® surface is carried out after the adhesive has hardened. We can offer a Busak+Shamban two-component epoxy-resin adhesive.

Please send for our detailed bonding instructions.

Safety precautions

When bonding Slydway® with epoxy-resin adhesives, the safety precautions in accordance with DIN 52900 must be observed. The working areas should be adequately ventilated. Smoking should be avoided during bonding and machining.

Machining

Slydway® can be machined mechanically after the bonding point has set. Slydway® materials can be machined quite easily.

Machining methods

Precision Milling

For precision milling tools such as face cutters with one or more cutting edges made from high-speed steel, tungsten carbide or ceramic materials can be used.

Surface qualities such as those achievable when grinding can be produced with high cutting rates (up to 800 m/min) and low feed rates. In order to achieve a good surface finish, a small cutting depth is to be recommended.

No cooling is generally needed when milling Slydway®.

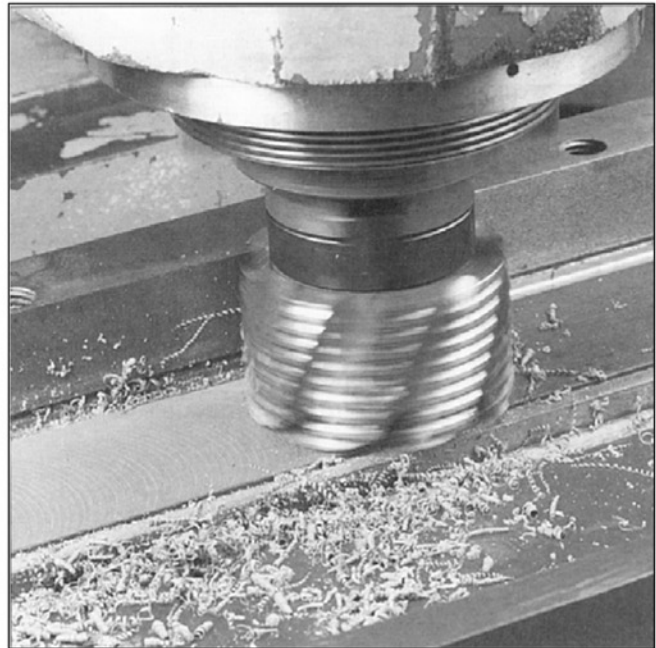

Figure 9 Precision Milling



Grinding

Grinding wheels with normal abrasives (e.g. special fused alumina, silicon carbide) can be used for grinding. The grinding wheels should have a medium grain (36) and a low hardness (I). The method of bonding can be ceramic (Ke) or may contain synthetic resin (Ba). Wet grinding is always recommended for grinding of Slydway®. The coolant dissipates the heat of grinding and provides a better surface finish. Grinding wastes have to be removed.

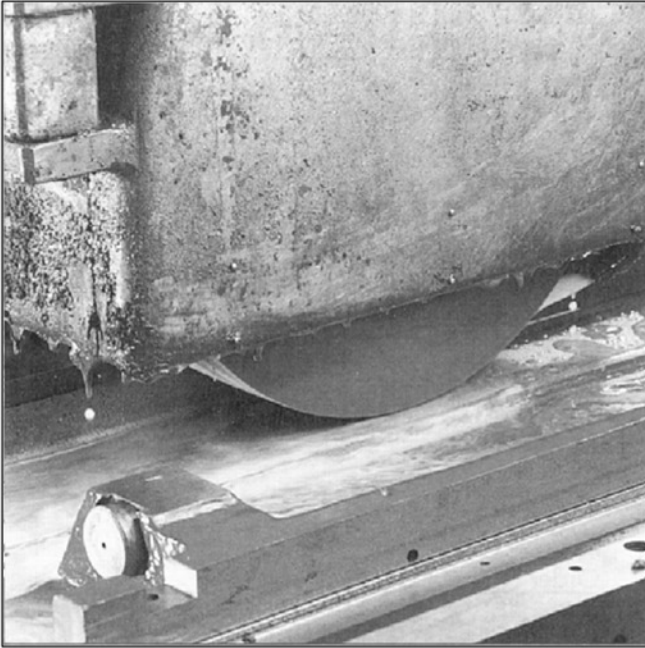

Figure 10 Grinding

Scraping

Milled and ground surfaces can be remachined by scraping to improve the surface quality and dimensional accuracy. Only sharply ground scraping tools should be used. Scraping can be performed manually or with a scraping machine. A grade of 2 is required for a precision surface, corresponding to 2 to 3 points per cm². A perfectly scraped or patterned surface enhances the tribological properties of the guides.

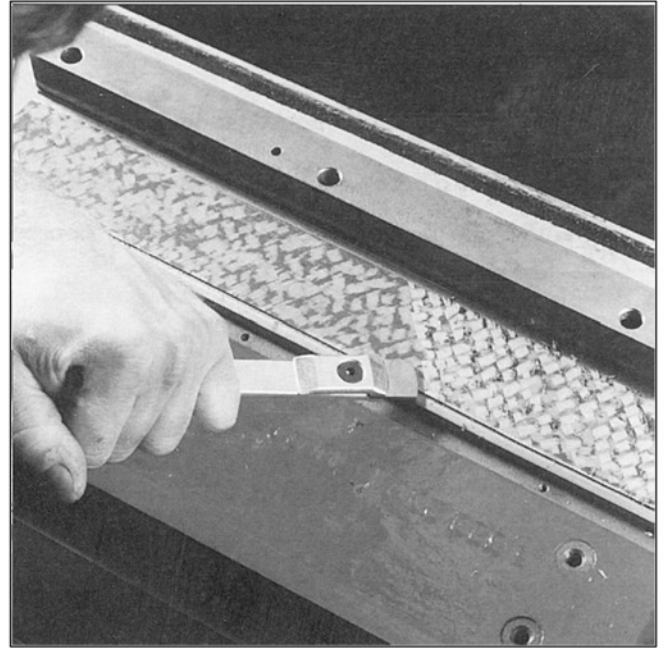

Figure 11 Scraping

Oil Grooves

Slydway® can be machined to incorporate oil or lubrication groove patterns. The configuration of the groove is optional. The optimum result is obtained by milling the oil grooves into the material to a depth of 0.5 - 0.6 mm. Milling completely through the material into the metal saddle is not recommended. For any pattern chosen, it is extremely important that the milled grooves maintain a generous, smooth radius which blends the top of the groove back to the surface of the material without creating any sharp edges. Oil grooves should never be machined closer than 6 mm to the edge and 15 mm from the ends of the bearing material.



Dimensions / Ordering

Slydway® is available cut to length or off-the-roll.

Standard strip thicknesses are 1.5 and 2.5 mm. Other thicknesses up to 5.0 mm are available on request.

The standard widths are shown in Table III. Other widths up to 300 mm can also be supplied.

For the standard dimensions, please use the order numbers from Table III. The desired length (m) has to be stated with the order number.

Limitations:

1. Up to and inclusive 3.0 mm thickness Turcite® TB can be delivered one-side treated, up to 300 mm width.
2. Up to and inclusive 3.5 mm thickness all standard materials, except Turcite® TB, can be delivered two-side treated, up to 200 mm width.
3. Up to and inclusive 4.0 mm thickness all standard materials, except Turcite® TB, can be delivered two-side treated, up to 140 mm width.
4. Up to and inclusive 5.0 mm thickness all standard materials, except Turcite® TB, can be delivered two-side treated, up to 60 mm width.

Table I Possible widths in relation to strip thickness

Thickness Up to and including	Turcite® Slydway® - max. width		
	Turcite® TB		Turcite® T51
	One-side treated	Two-side treated	Two-side treated
3.0 mm	300 mm*	200 mm	200 mm*
3.5 mm	Not available	200 mm*	200 mm*
4.0 mm	Not available	140 mm*	140 mm*
5.0 mm	Not available	60 mm*	60 mm*

* Standard execution with "0" in the fifth character are following this limitations

Table II Length of the roll in relation to strip thickness

Thick-ness w	Turcite® TB Slydway®	Turcite® T51 Slydway®
	Length of the roll max.	Length of the roll max.
0.5 mm	50,0 m	70.0 m
1.0 mm	26,0 m	37.0 m
1.5 mm	18.5 m	24.0 m
2.0 mm	13.5 m	17.0 m
2.5 mm	11.0 m	13.0 m
3.0 mm	8.0 m	10.5 m
3.5 mm	7.0 m	8.5 m
4.0 mm	5.0 m	7.0 m
4.5 mm	5.0 m	5.5 m
5.0 mm	4.5 m	5.0 m

Highlighted dimensions are standard.

Adhesive for Slydway®

We can offer a packaged unit comprising:

50 g resin and 20 g accelerator Order No. XZZS000006.

The quantity supplied is sufficient for bonding approx. 0.25 m² of Slydway®.

Table III Standard dimensions and order no's for Turcite® TB Slydway® and Turcite® T51 Slydway®

Thickness 1.5 mm Length 18.5 m		Thickness 2.5 mm Length 11.0 m	
Width mm	Order No.	Width mm	Order No.
10	GLB500010-TB/T51	10	GLC500010-TB/T51
15	GLB500015-TB/T51	15	GLC500015-TB/T51
20	GLB500020-TB/T51	20	GLC500020-TB/T51
25	GLB500025-TB/T51	25	GLC500025-TB/T51
30	GLB500030-TB/T51	30	GLC500030-TB/T51
35	GLB500035-TB/T51	35	GLC500035-TB/T51
40	GLB500040-TB/T51	40	GLC500040-TB/T51
45	GLB500045-TB/T51	45	GLC500045-TB/T51
50	GLB500050-TB/T51	50	GLC500050-TB/T51
60	GLB500060-TB/T51	60	GLC500060-TB/T51
70	GLB500070-TB/T51	70	GLC500070-TB/T51
80	GLB500080-TB/T51	80	GLC500080-TB/T51
90	GLB500090-TB/T51	90	GLC500090-TB/T51
100	GLB500100-TB/T51	100	GLC500100-TB/T51
125	GLB500125-TB/T51	125	GLC500125-TB/T51
150	GLB500150-TB/T51	150	GLC500150-TB/T51

Ordering example

1 roll (thickness 1.5 mm, length 18.5 m, width 35 mm)

Material: Turcite® TB

Order: 1 roll GLB500035-TB

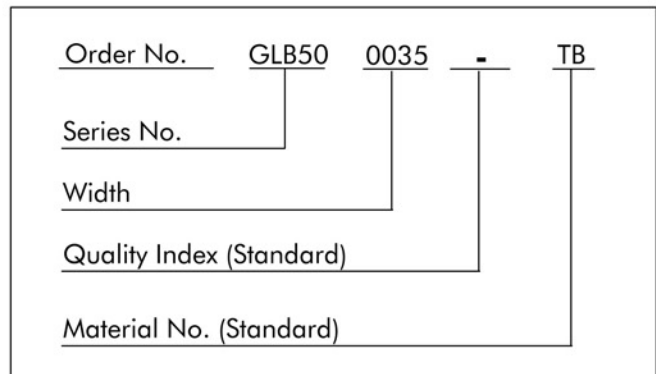



■ Quality criteria

The cost-effective use of seals and bearings is highly influenced by the quality criteria applied in production. Seals and bearings from Busak+Shamban are continuously monitored according to strict quality standards from material acquisition through to delivery.

Certification of our production plants in accordance with international standards QS 9000 / ISO 9000 meets the specific requirements for quality control and management of purchasing, production and marketing functions.

Our quality policy is consistently controlled by strict procedures and guidelines which are implemented within all strategic areas of the company.

All testing of materials and products is performed in accordance with accepted test standards and specifications, e.g. random sample testing in accordance with DIN ISO 2859, part 1. Inspection specifications correspond to standards applicable to individual product groups (e.g. for O-Rings: ISO 3601).

Our sealing materials are produced free of chlorofluorinated hydrocarbons and carcinogenic elements.

The tenth digit of our part number defines the quality characteristics of the part. A hyphen indicates compliance with standard quality criteria outlined in this catalogue. Customer-specific requirements are indicated by a different symbol in this position. Customers who require special quality criteria should contact their local Busak+Shamban sales office for assistance. We have experience in meeting all Customer quality requirements.

■ Storage and shelf life

Seals and bearings are often stored as spare parts for prolonged periods. Most rubbers change in physical properties during storage and ultimately become unserviceable due, e.g., to excessive hardening, softening, cracking, crazing or other surface degradation. These changes may be the result of particular factors or combination of factors, such as the action of deformation, oxygen, ozone, light, heat, humidity or oils and solvents.

With a few simple precautions, the shelf life of these products can be considerably lengthened.

Fundamental instructions on storage, cleaning and maintenance of elastomeric seal elements are described in international standards, such as:

DIN 7716 / BS 3F68:1977,
ISO 2230, or
DIN 9088

The standards give several recommendations for the storage and the shelf life of elastomers, depending on the material classes.

The following recommendations are based on the several standards and are intended to provide the most suitable conditions for storage of rubbers. They should be observed to maintain the optimum physical and chemical values of the parts:

Heat

The storage temperature should preferably be between +5 °C and +25 °C. Direct contact with sources of heat such as boilers, radiators and direct sunlight should be avoided.

If the storage temperature is below +15 °C, care should be taken to avoid distorting them during handling at that temperature as they may have stiffened. In this case the temperature of the articles should be raised to approximately +20 °C before they are put into service.

Humidity

The relative humidity in the store room should be below 70%. Very moist or very dry conditions should be avoided. Condensation should not occur.

Light

Elastomeric seals should be protected from light sources, in particular direct sunlight or strong artificial light with an ultraviolet content. The individual storage bags offer the best protection as long as they are UV resistant.

It is advisable to cover any windows of storage rooms with a red or orange coating or screen.

Radiation

Precaution should be taken to protect stored articles from all sources of ionising radiation likely to cause damage to stored articles.



Oxygen and ozone

Where possible, elastomeric materials should be protected from circulating air by wrapping, storage in airtight containers or by other suitable means.

As ozone is particularly deleterious to some elastomeric seals, storage rooms should not contain any equipment that is capable of generating ozone, such as mercury vapour lamps, high voltage electrical equipment, electric motors or other equipment which may give rise to electric sparks or silent electrical discharges. Combustion gases and organic vapour should be excluded from storage rooms as they may give rise to ozone via photochemical processes.

Deformation

Elastomeric materials should, wherever possible, be stored in a relaxed condition free from tension, compression or other deformation. Where articles are packed in a strain-free condition they should be stored in their original packaging.

Contact with liquid and semi-solid materials

Elastomeric seals should not be allowed to come into contact with solvents, oils, greases or any other semi-solid materials at any time during storage, unless so packed by the manufacturer.

Contact with metal and non-metals

Direct contact with certain metals, e.g. manganese, iron and particularly copper and its alloys, e.g. brass and compounds of these materials are known to have deleterious effects on some rubbers. Elastomeric seals should not be stored in contact with such metals.

Because of possible transfer of plasticisers or other ingredients, rubbers must not be stored in contact with PVC. Different rubbers should preferably be separated from each other.

Cleaning

Where necessary, cleaning should be carried out with the aid of soap and water or methylated spirits. Water should not, however, be permitted to come into contact with fabric reinforced components, bonded seals (because of corrosion) or polyurethane rubbers. Disinfectants or other organic solvents as well as sharp-edged objects must not be used. The articles should be dried at room temperature and not placed near a source of heat.

Shelf life and shelf life control

The useful life of an elastomeric seal will depend to a large extent on the type of rubber. When stored under the recommended conditions (above sections) the below given shelf life of several materials should be considered.

AU, Thermoplastics	4 years
NBR, HNBR, CR	6 years
EPDM	8 years
FKM, VMQ, FVMQ	10 years
FFKM, Isolast®	18 years
PTFE, Turcon®	unlimited

Elastomeric seals should be inspected after the given period. After this giving an extension period is possible.

Rubber details and components less than 1.5 mm thick are liable to be more seriously affected by oxidation degradation even when stored in satisfactory conditions as recommended. Therefore they may be inspected and tested more frequently than it is mentioned above.

Rubber details / seals in assembled components

It is recommended that the units should be exercised at least every six months and that the maximum period a rubber detail be allowed to remain assembled within a stored unit, without inspection, be a total of the initial period stated above and the extension period. Naturally this will depend on the design of the unit concerned.

Contact your local marketing company for further information:

Europe	Telephone	Americas	Telephone
AUSTRIA - Vienna (ALBANIA, BOSNIA AND HERZEGOVINA, MACEDONIA, SERBIA AND MONTENEGRO, SLOVENIA)	+43 (0) 1 406 47 33	AMERICAS - REGIONAL	+1 260 749 9631
BELGIUM - Dion-Valmont (LUXEMBOURG)	+32 (0) 10 22 57 50	BRAZIL - São Paulo	+55 11 3372 4500
BULGARIA - Sofia (BELARUS, ROMANIA, TURKEY, UKRAINE)	+359 (0)2 969 95 99	CANADA - Etobicoke, ON	+1 416 213 9444
CROATIA - Zagreb	+385 (0) 1 24 56 387	MEXICO - Mexico City	+52 55 57 19 50 05
CZECH REPUBLIC - Rakovník (SLOVAKIA)	+420 313529 111	USA, East - Conshohocken, PA	+1 610 828 3209
DENMARK - Copenhagen	+45 48 22 80 80	USA, Great Lakes - Fort Wayne, IN	+1 260 482 4050
FINLAND - Vantaa (ESTONIA, LATVIA)	+358 (0) 207 12 13 50	USA, Midwest - Lombard, IL	+1 630 268 9915
FRANCE - Maisons-Laffitte	+33 (0) 1 30 86 56 00	USA, Mountain - Broomfield, CO	+1 303 469 1357
GERMANY - Stuttgart	+49 (0) 711 7864 0	USA, Northern California - Fresno, CA	+1 559 449 6070
GREECE	+41 (0) 21 631 41 11	USA, Northwest - Portland, OR	+1 503 595 6565
HUNGARY - Budaörs	+36 (06) 23 50 21 21	USA, South - N. Charleston, SC	+1 843 747 7656
ITALY - Livorno	+39 0586 22 6111	USA, Southwest - Houston, TX	+1 713 461 3495
THE NETHERLANDS - Barendrecht	+31 (0) 10 29 22 111	USA, West - Torrance, CA	+1 310 371 1025
NORWAY - Oslo	+47 22 64 60 80		
POLAND - Warsaw (LITHUANIA)	+48 (0) 22 863 30 11	Asia Pacific	Telephone
RUSSIA - Moscow	+7 495 982 39 21	ASIA PACIFIC REGIONAL	+65 6 577 1778
SPAIN - Madrid (PORTUGAL)	+34 (0) 91 71057 30	CHINA - Hong Kong	+852 2366 9165
SWEDEN - Jönköping	+46 (0) 36 34 15 00	CHINA - Shanghai	+86 (0) 21 6145 1830
SWITZERLAND - Crissier	+41 (0) 21 631 41 11	INDIA - Bangalore	+91 (0) 80 2245 5157
UNITED KINGDOM - Solihull (EIRE)	+44 (0) 121 744 1221	JAPAN - Tokyo	+81 (0) 3 5633 8008
AFRICA REGIONAL	+41 (0) 21 631 41 11	KOREA - Seoul	+82 (0) 2 761 3471
MIDDLE EAST REGIONAL	+41 (0) 21 631 41 11	MALAYSIA - Kuala Lumpur	+60 (0) 3 9059 6388
		TAIWAN - Taichung	+886 4 2382 8886
		THAILAND - Bangkok	+66 (0) 2732-2861
		SINGAPORE	
		and all other countries in Asia	+65 6 577 1778

www.tss.trelleborg.com